

Read the owner's manual completely before you use the trailer.



UtilityMate[®] Trailer Owner's Manual

IMPORTANT SAFETY CHECK LIST

PLEASE NOTE: Trailers are not generally used every day. A trailer may sit for extended periods of time between uses.

It is very important to check all components thoroughly on the trailer before use.

- Make sure that the towing vehicle and the hitch on your vehicle is more than capable of towing the trailer. It is important to check your vehicle owner's manual for trailer ratings.
- Make sure the hitch is properly secured to the ball of the towing vehicle.
- Make sure coupler is locked and the safety chains are attached to the trailer and the vehicle.
- Check the operation of all lights. Operating lights are mandatory on a trailer and must operate correctly.
- Inspect the trailer and all parts before use.
- Check to insure that all Wheel Bolts are tight. Torque to 80 ft.-lbs. Re-tighten after the first 50 miles, or 80 kilometers.
- Check the tire pressure. Maximum 80 PSI (552 KPA) when carrying the maximum rated load.
- Re-pack the wheel bearings every 2000 miles or 3200 kilometers or a minimum of once every year.
- Check that the trailer coupler is fastened securely onto the trailer ball. The trailer ball must be a 2" ball.
- If your trailer has an optional side kit make sure all the bolts and pins are in place and secured tight before transporting your trailer.
- Do not exceed the Gross Vehicle Weight Rating (G.V.W.R.) which is shown on the trailer serial / certification label.
- Balance and secure the load on the trailer. See the trailer loading section in this manual.
- Lubrication of the coupler, springs and the tilt mechanism should be done periodically to stop corrosion and keep parts moving freely.

By following these simple instructions, you will maximize the life of your trailer and help safely transport your cargo.

⋮⋮⋮ **WARNING!!!** ⋮⋮⋮

DO NOT ABUSE THE TRAILER. The UtilitySport™ trailer performance is best if you follow the guidelines set fourth in this manual. Do not force the UtilitySport™ trailer to do a job it is not designed for. Know your UtilitySport™ trailer; learn its limitations and applications.

- **KEEP CHILDREN AWAY.** Be sure children are kept a safe distance from the UtilitySport trailer operating area.
- **NEVER** sit or ride on the UtilitySport™ trailer. Serious injury or death could occur.
- **EXERCISE EXTREME CAUTION WHEN TILTING THE TRAILER.**

There are many areas of the UtilitySport™ trailer where injury can occur if used improperly. The UtilitySport™ trailer may tilt quickly and unexpectedly during the loading and unloading process. The tilt option should not be used for heavy loads.

- Ramps should always be used for loading heavy items.
- **DO NOT** drive with UtilitySport™ trailer in tilted position.
- If the UtilitySport™ trailer is incorrectly attached to the vehicle, it could pull away from the vehicle and fall off.
- Always check your tire pressure before transporting your trailer.
- Secure trailer to the towing vehicle before transportation. Make sure coupler is locked and the safety chains are attached to the trailer and the vehicle.
- Secure your cargo into the trailer properly and in compliance to local laws.
- Always test your trailer lights before transporting your trailer. Also check your light hookup from time to time during transport, just to make sure your connection has not come loose from the vehicle.
- When driving do not exceed the speed limit. Braking time can be considerably longer when a vehicle is towing a loaded trailer.
- Any modifications made to the trailer or parts of the trailer will void the trailer warranty and release UtilitySport™ any and any related companies of any responsibility for liability, damages, injuries or accidents incurred.
- Any improper use or failure to follow the safety check list herein will void the trailer warranty and release UtilitySport™ and all related companies of any responsibility for liability, damages, injuries or accidents incurred.

FEATURES (See Figure #1)

A. How To Use The “Extended Tongue” Feature

1= Regular Position 2 = Extended Position

The tongue can be installed in two positions. The Extended position will allow the use of the optional extension / side kit.

How to: **Make sure you first properly support the trailer to allow the safe movement of the tongue forward from below the frame.** With the proper size tools, remove the 24mm x 12cm Hex Bolt and Lock Nut at the back of the tongue. Pull the tongue forward until the holes at the back of the tongue line up with the middle tongue mount bracket. Re-insert the 24mm x 12cm Hex Bolt and Lock Nut and properly re-tighten. Slide the extra 12v wire back to the tongue after changing the tongue position, making sure the tongue plug is still firmly connected to the 12v trailer frame plug. The Hitch Pin and L-Bolt do not need to be removed as the tongue will slide forward or back while this pin is still in position.

B. How To Use The “2 Position Axle”

1= Back Position 2 = Front Position

The UtilitySport™ trailer comes with a 2 position axle design. This feature allows the user to control how much of the trailers load is distributed to the vehicle. This feature has the benefit of improved handling under low load conditions and reduced tongue weight under heavy load conditions. Also the feature allows the trailer to remain or not stay in a tilt / dump position depending on the position of the axle.

How to: **Make sure you first properly support the back of the trailer with blocks then use a jack on the tongue to lift the trailer securely so that the tires are about an inch of the ground.** Using the correct tools, remove the (4) 19mm x 9cm bolts along with the trailer fenders. Slide the axle, spring and tire assembly to the desired position. Reinsert the (4) 19mm x 9cm hex bolts through the fender and spring then into the frame channel and secure with the 21mm lock nuts. You will need to lower the trailer to line up the front hole on the spring. The back bolt goes under the leaf of the spring to hold it against the frame. Make sure all parts are properly installed, secured, and tested before you use your trailer.

Note: For general use you may wish to leave the axle in a fixed position. In this case the preferred axle location would be in the forward position. For heavy loads, the axle **must** be in the **forward** position..

C. How to Use the “Tilt / Dump” Feature (NOT AVAILABLE)

1= Extended Tongue Position 2 = Regular Tongue Position

The UtilitySport™ trailer has a tilt feature to help with loading and unloading of cargo.

How to: First make sure the trailer is attached to the towing vehicle. Remove the front Hitch Pin and L-Bolt on the tongue, this will allow you to tilt the trailer to the dump position.

CAUTION WHEN TILTING THE TRAILER: The trailer may tilt quickly and unexpectedly during the loading and unloading process.

Note: **NOT AVAILABLE ON THE UM583-MC**

FEATURES

For Instructions see "Features" section in this manual

1

A

1

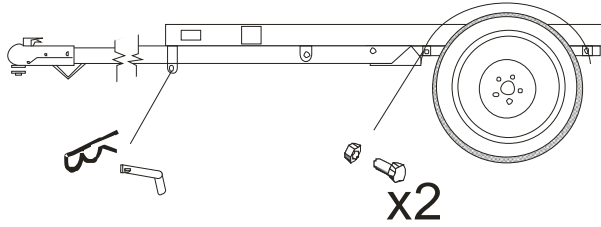

2

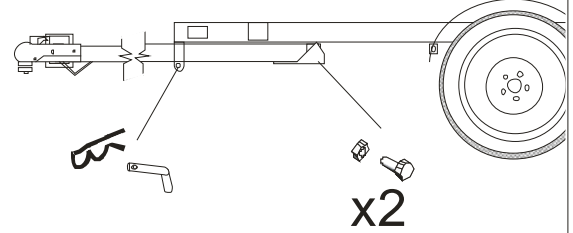

B

1

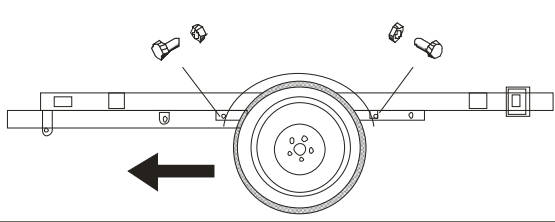
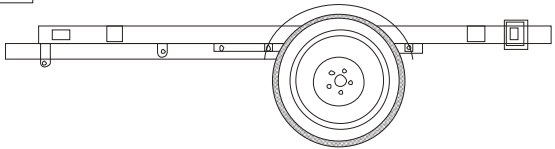

2

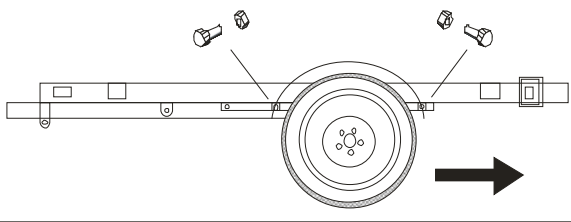
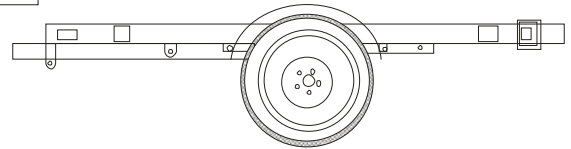

C

1

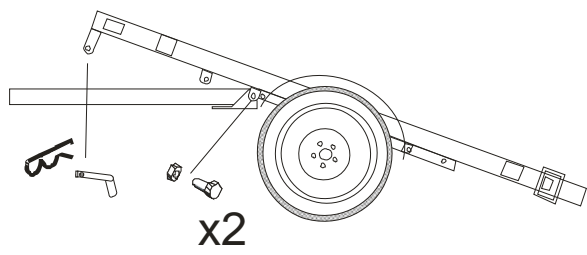

2

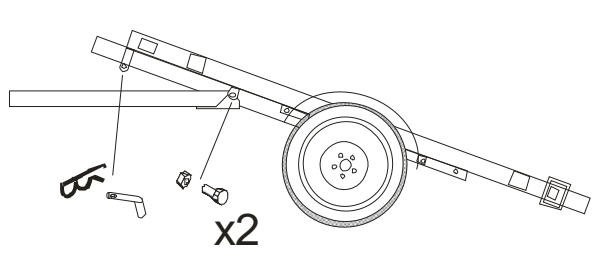

PARTS LIST (See Figure #2)

No.	Description	Qty
A1	Coupler	1
A2	Tongue	1
A3	Front Gate	1
A4	Side Rail	2
A5	Bed Frame	1
A6	Ramp	1
A7	L-Latch	1
A8	Spring Plate	2
A9	U-Bolt	4
A10	Axle	2
A11	Leaf Spring	2
A12	License Plate	1
A13	Tail Light Protector	2
A14	Tail Light	2
A15	Fender	2
A16	12" Tire/Wheel	2
A17	Side Mark	2
B1	M12X75 Bolt	2
B2	Flat Washer12	4
B3	M12 Nylon Lock Nut	2
B4	M16X110 Bolt	1
B5	Flat Washer 16	2
B6	M16 Nylon Lock Nut	1
B7	R Pin	1
B8	M10x90 Bolt	2
B9	Flat Washer 10	4
B10	M10 Nylon Lock Nut	2
B11	M10 Nylon Lock Nut	8
B12	Flat Washer 10	8
B13	Chrome Plated Dust Cap	2
B14	M12X85 Bolt	4
B15	Flat Washer 12	8
B16	M12 Nylon Lock Nut	4
B17	Tire Lug Nut	10
B18	M8X55 Bolt	6
B19	Flat Washer 8	12
B20	M8 Nylon Lock Nut	6
B21	M8X70 Bolt	4
B22	Flat Washer 8	8
B23	M8 Nylon Lock Nut	4
B24	Chrome Plated Lug Nut Cover	10
B25	Safety Chain	1

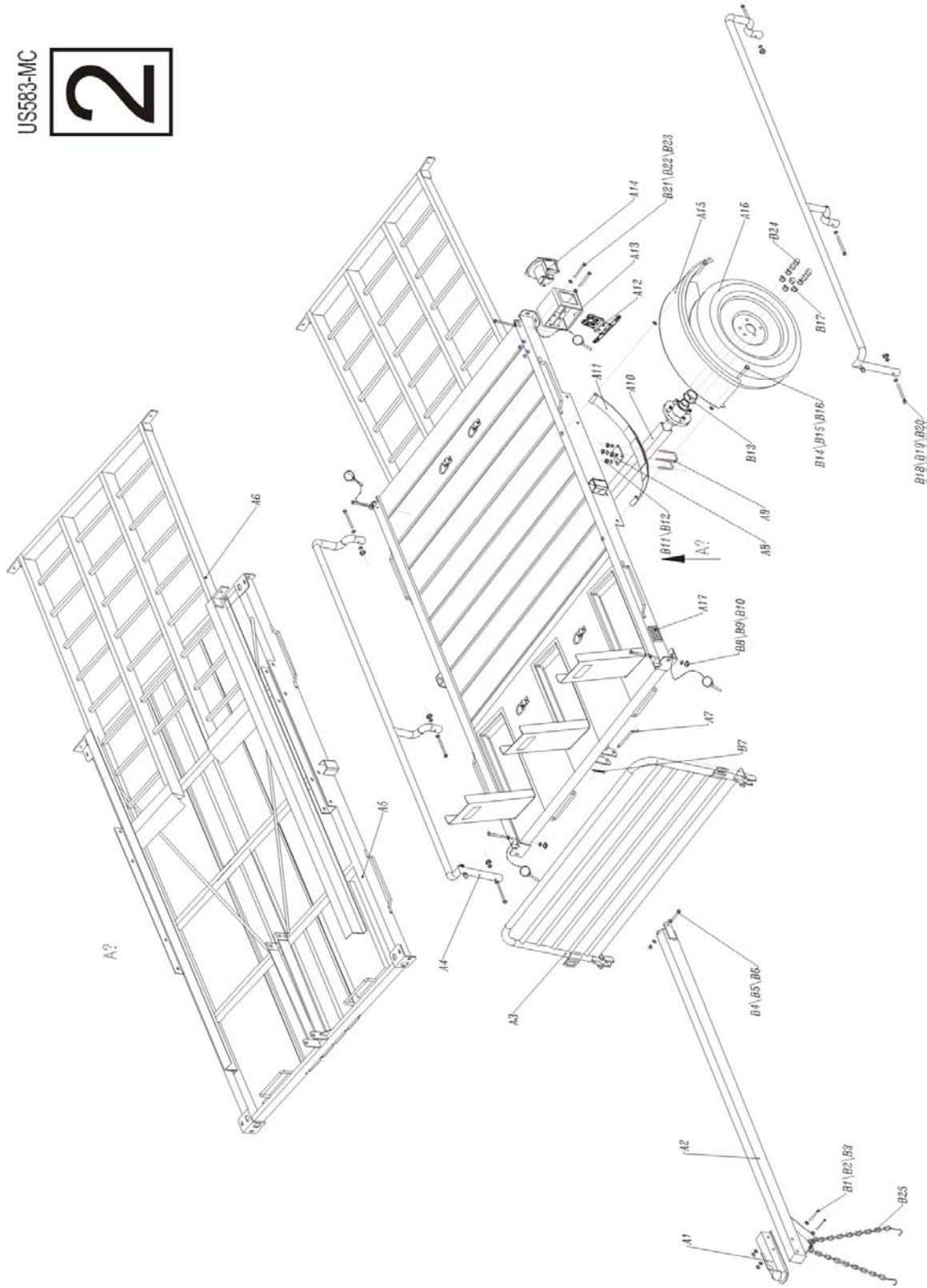

LIGHTING & WIRING (See Figure #3)

SYMBOL	COLOR	DESCRIPTION	OPERATION	
G	GREEN	Passenger Side / Right	Right Signal	Brakes
B	BROWN	Running Lights	Taillight Marker	Yellow Side Marker
Y	YELLOW	Driver Side / Left	Left Signal	Brake
W	WHITE	Ground	Trailer Ground	

To test vehicle wiring:

You will need a 12V light tester. Attach the wire clamp of the tester to the ground wire on the vehicle plug (see Fig 3). Then touch the tester pin into one of the vehicle plug contacts. Turn on the corresponding vehicle operation i.e. Running lights. This will illuminate the tester light if the vehicle wiring is correct. Follow the same procedure for the signal and brake lights.

To test the Trailer wiring:

Once you have confirmed that the vehicle trailer plug is operating properly, connect the trailer plug to your vehicle. Proceed to test each of the lights and power leads using your 12V light tester. Follow the wiring legend and diagram to test each corresponding wire for power when trailer light is not operating.

Always be sure to check your brake, running and signal lights before each use. Make sure that all of your connections are solid and that all wiring is in good condition.

Note: Bare, striped or pinched wire will cause a short in the trailer, which will cause the vehicle to blow a fuse. A solid ground is required for your lights to work properly. All contacts must be to bare metal. Light covers should be well maintained and kept clean. Be sure that your lights are always visible, not obstructed by your load.

WIRING DIAGRAM

3

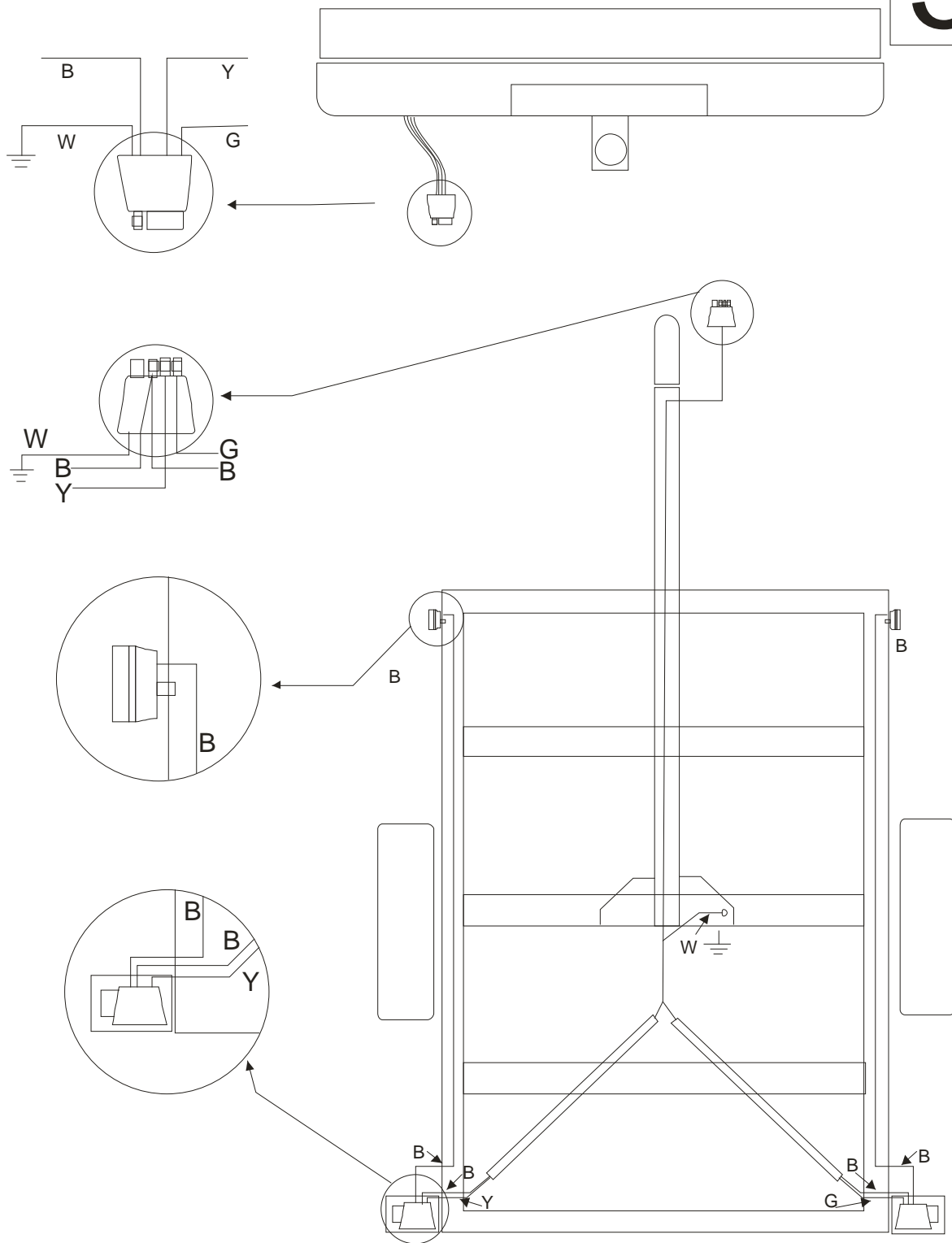

LOADING THE TRAILER

- A. Distribute the weight evenly on the bed of the trailer.
- B. Center the load over the axle, keeping about 10% of the weight on the tongue.
- C. Center the load from side to side.
- D. Always secure your cargo into the trailer properly and in compliance to local laws.

CAUTION: Do not build your trailer load higher than 3'. Higher loading will affect trailer handling due to increased wind resistance. This may cause violent movements, accidents and serious injury.

TRAILER CAPACITY

Never overload your trailer. Each trailer has a maximum payload that should not be exceeded. Overloading your trailer could cause serious damage to your trailer as well as the towing vehicle. Please refer to your trailer serial / certification label located on the frame of the trailer for capacity details.

The Gross Vehicle Weight Rating (G.V.W.R.) is:

The Weight of the trailer + The Maximum payload the trailer can carry. The trailer weight and the payload must not exceed this (G.V.W.R.) weight rating.

Be sure that any load carried in your trailer does not extend beyond the frame of your trailer. Never place loads on one side only.

TONGUE WEIGHT

The tongue weight is 10% of the load (this does not include the weight of the trailer).

The load is divided so that 90% of the load is over the axle and 10% is over the tongue.

TRAILER COUPLER

ITEM#	DESCRIPTION
1	2" Trailer Coupler
2	Locking Handle
3	Channel Lock
4	Adjustment Nut
5	2" Trailer Ball (Not Included)

To adjust coupler to ball:

Set coupler and tongue on to the 2" trailer ball on your vehicle.

Raise the locking lever, push up on channel lock and turn nut to tighten or loosen the coupler.

Proper adjustment is obtained when coupler is as tight as possible on the ball and locking lever can still be opened and closed.

Before towing your trailer be sure to check the capacity of your Trailer hitch on your vehicle (never exceed this or your trailers capacity). The UtilitySport™ trailer is equipped with a 2" coupler and must be used with a 2" trailer ball. Make sure that the trailer ball is completely engaged in the coupler ball.

WHEEL & HUB ASSEMBLY

NOTE: Bearings should be re-packed every 2000 miles or 3200 kilometers. Your trailer dealer or any automotive shop is equipped and able to repack the bearings if you do not know how or feel uncomfortable doing this task. **For you convenience, a grease zerk fitting is located behind each wheel which only requires the use of a grease gun to service, or you can do it the manually as follows;**

Re-packing Wheel Bearings

1. Loosen wheel bolts (Do not remove!).
2. Support trailer so wheels are off the ground safely and secured.
3. Remove bolts and wheel.
4. Disassemble hub.
5. Clean hub and pack bearings with wheel bearing grease.
6. Re-install bearings, nut and cotter pin.

Caution: DO NOT over tighten nut. The hub must turn freely and without play.

7. Re-attach bolts and wheel (Torque to 80 lbs.).

CERTIFICATE OF ORIGIN

To receive your certificate of origin and VIN Tag and validate your warranty, please register online at www.utilitymate.com or fill out this form completely and mail OR fax immediately along with a copy of your purchase receipt. Failure to register within 30 days of proof purchase date will void warranty;

Send To:

***** Must Enclose Copy of Receipt *****

UtilityMate™
PO BOX 116
MERLIN, OR 97532

Fax: 541.472.8176

Your Name: _____ Date Purchased: _____
Address: _____
City: _____
State: _____
Zip/ Postal Code: _____
Telephone #: _____
Trailer Model: _____
Age: 18-24 _____ 25-34 _____ 35-49 _____ 50-64 _____ 65+ _____
Male: _____ Female: _____

Name of Dealer: _____
Address: _____
City: _____
State: _____
Zip/ Postal Code: _____

WARRANTY STATEMENT

UtilityMate™ offers a 90 Day limited warranty on each new UtilityMate® trailer against manufacturing defects in workmanship and materials.

The obligation under this warranty is limited to the replacement or repair at the manufacturer's factory, or at a point designated by the manufacturer, of such part as shall appear to the manufacturer upon inspection of such part to have been defective in material or workmanship. This warranty does not obligate UtilityMate® to bear the cost of labor or transportation

Charges in connection with the replacement or repair of defective parts, nor shall it apply to a product upon which alterations have been made or for equipment misused, neglected or improperly installed. UtilityMate® reserves the right to improve any product through changes in design or materials as it may deem desirable without being obligated to incorporate such changes in products of previous manufacture.

Bills for service, labor, or other expenses which have been incurred by the buyer without express approval or authorization by UtilityMate® will not be accepted.

If your Trailer fails to operate properly, or fails within the warranty period, the following steps should be taken.

1. For warranty work of defective components return parts to authorized UtilityMate® Dealer or contact UtilityMate® at www.utilitymate.com . Include your name, return address, phone # and a description of the problem, and contact phone number.
2. A copy of the receipt including date of purchase is necessary for any warranty claim.
3. If damages are due to abuse or misuse, owner will be charged for parts and labor.
4. If any of the components of your Trailer are found to be faulty due to defective material or workmanship, they will be repaired at "NO CHARGE" and returned with transportation charges prepaid. If failure occurred because of abuse, neglect or misuse, and estimate of costs to repair will be submitted back to the owner. Repair will not be completed until charges are authorized by the owner. After repairs are completed the material will be returned with transportation charges collect.

For further information and customer assistance go to www.utilitymate.com